

UF200BMA Series

(Axial Fan)

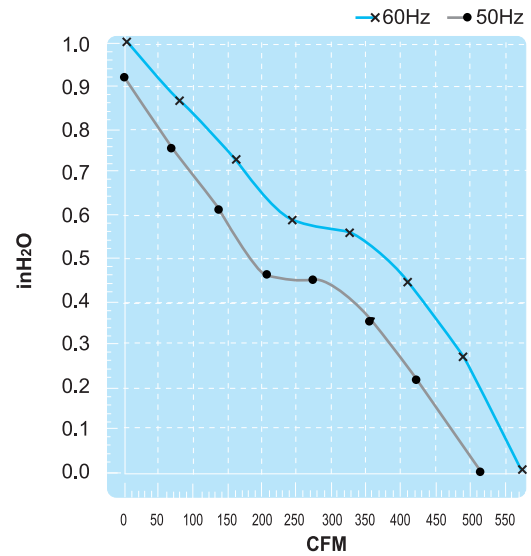

Thermal Protection

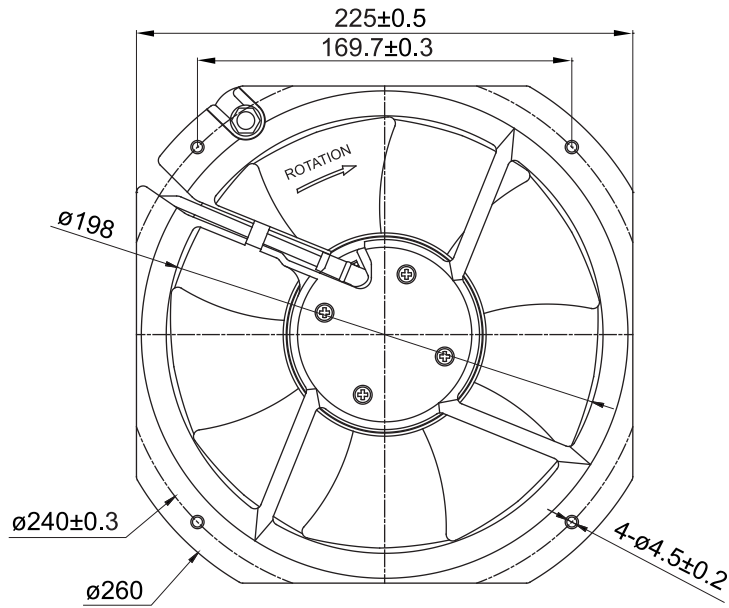
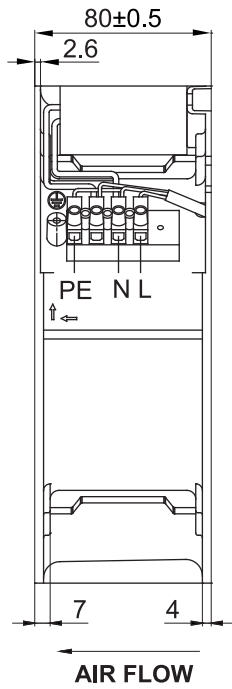

Spec.	Rated Voltage	Frequency	Input Power	Rated Current	Locked Current	Speed	Maximum Air Flow	Maximum Air Flow	Maximum Pressure	Maximum Pressure	Capacitor	Noise	Weight
Model	V	Hz	W	A	A	RPM	m ³ /min.	CFM	mmH ₂ O	InchH ₂ O	μF/VDB	dB	kg
UF200BMA11H2C2A	115V	50	73	0.75	1.30	2700	14.7	520	23.3	0.92	8/250	65	2.4
		60	75	0.66	1.40	3100	16.5	580	25.4	1.00		68	
UF200BMA23H2C2A	230V	50	72	0.38	0.62	2700	14.7	520	23.3	0.92	2/450	65	2.4
		60	77	0.34	0.63	3100	16.5	580	25.4	1.00		68	