

Counter Rotating Fan

60mm

San Ace 60

76mm thick (CR type)



General Specifications With a pulse sensor Specifications for pulse sensors ⇨ Refer to Page 239

*Please inquire about other specifications.

- Material Frame: Plastics (Flammability: UL94V-0),
Impeller: Plastics (Flammability: UL94V-1)
- Life Expectancy Varies for each model (L10: Survival rate: 90% at 60°C, rated voltage, and continuously run in a free air state)
- Lead Wire Inlet ⊕ red ⊖ black Sensor yellow
Outlet ⊕ orange ⊖ gray Sensor purple
- Storage Temperature ... -30°C to +70°C (Non-condensing)

60mm × 76mm thick (Mass : 230g) CR type

Specifications

Model No.	Rated Voltage (V)	Operating Voltage Range (V)	Rated Current (A)	Rated Input (W)	Rated Speed (min ⁻¹) Inlet Outlet	Air Flow (m ³ /min) (CFM)	Static Pressure (Pa) (inchH ₂ O)	SPL (dB[A])	Operating Temperature Range (°C)	Life Expectancy (h)
9CR0612S001	12	10.8 to 13.2	3.2	38.4	11,500 7,000	2.26 80	550 2.21	66	-10 to +60	40,000
9CR0612H001			2.7	32.4	10,300 6,500	1.98 70	450 1.81	64		

Dimensions (Unit : mm)

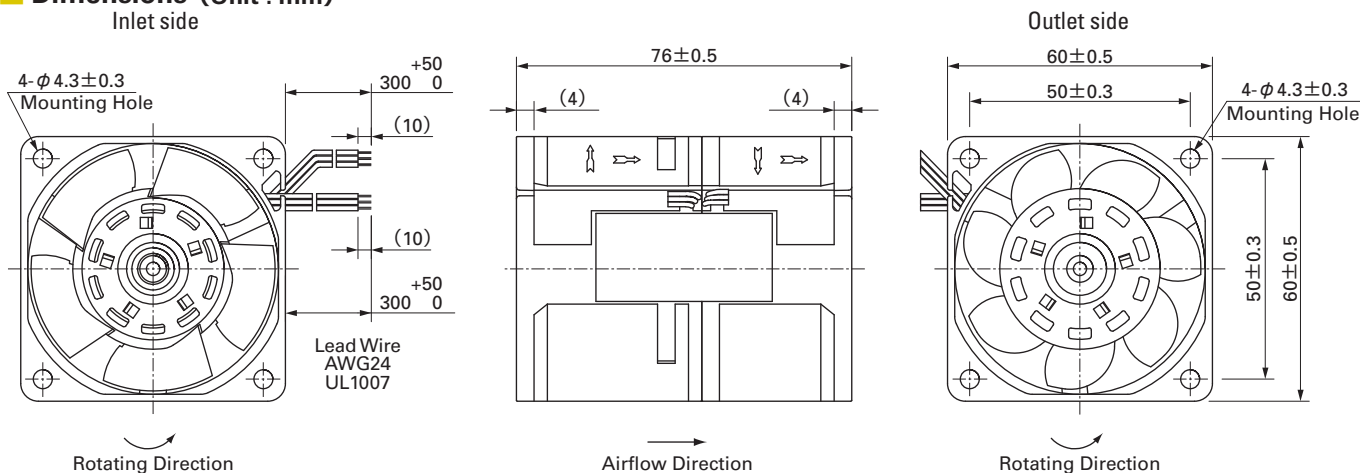

Reference dimension of mounting holes and vent opening (Unit : mm)

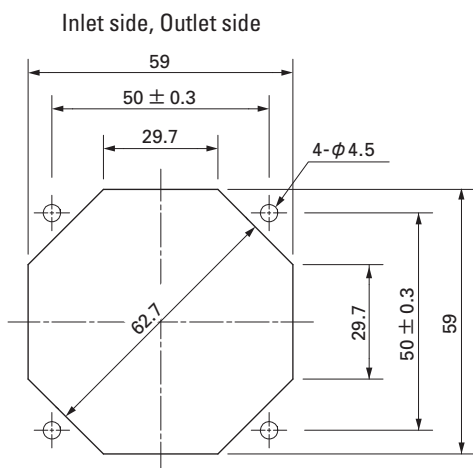

Options (Unit : mm)

Finger guards

Model : 109-139E Surface treatment : Nickel-chrome plating (silver) Color
 : 109-139H : Cation electropainting (black)

Inlet side, Outlet side

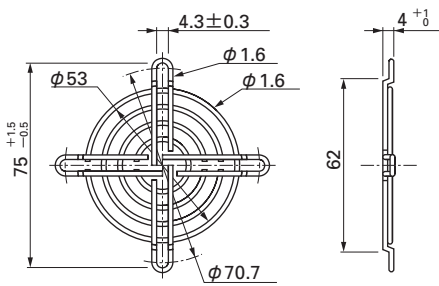

Resin finger guards

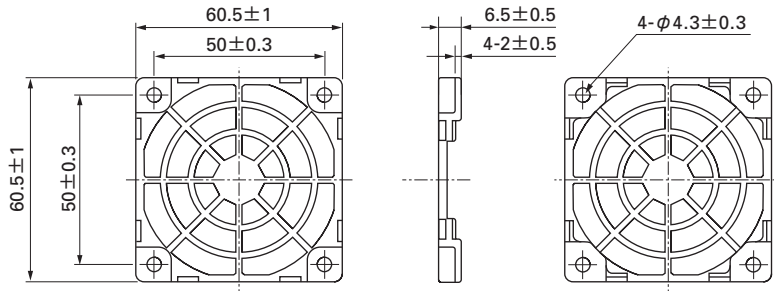

Resin filter kits

Model : 109-1003F13 (13PPI), 109-1003F20 (20PPI)
 : 109-1003F30 (30PPI), 109-1003F40 (40PPI)

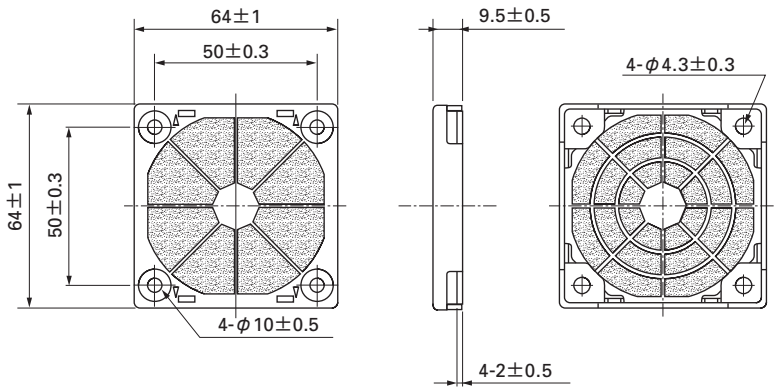

Air Flow and Static Pressure Characteristics

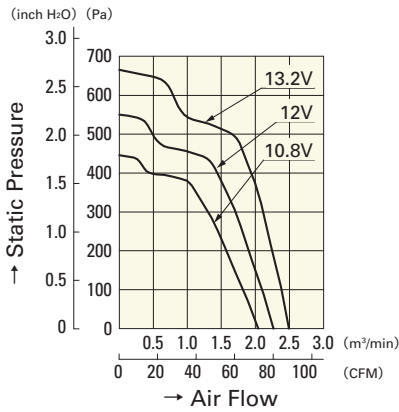

9CR0612S001

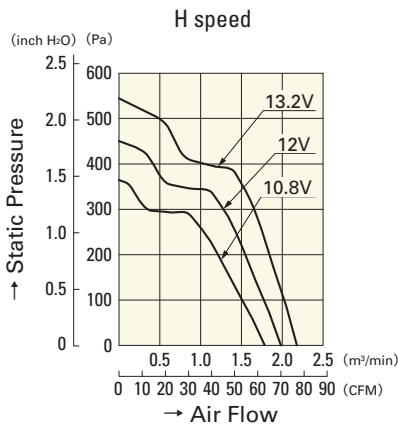

9CR0612H001