

40x56mm

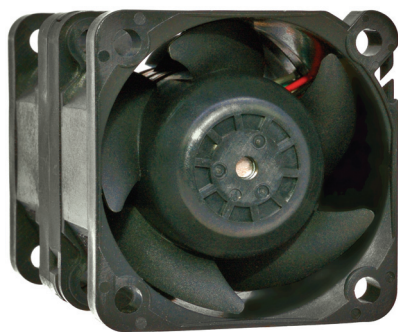

R40W CA Series

- ✓ Up to 25% Lower Power Requirement than Previous Designs
- ✓ Impeller and Motor Optimized for Improved Efficiency
- ✓ Permanently Lubricated Dual Ball Bearings

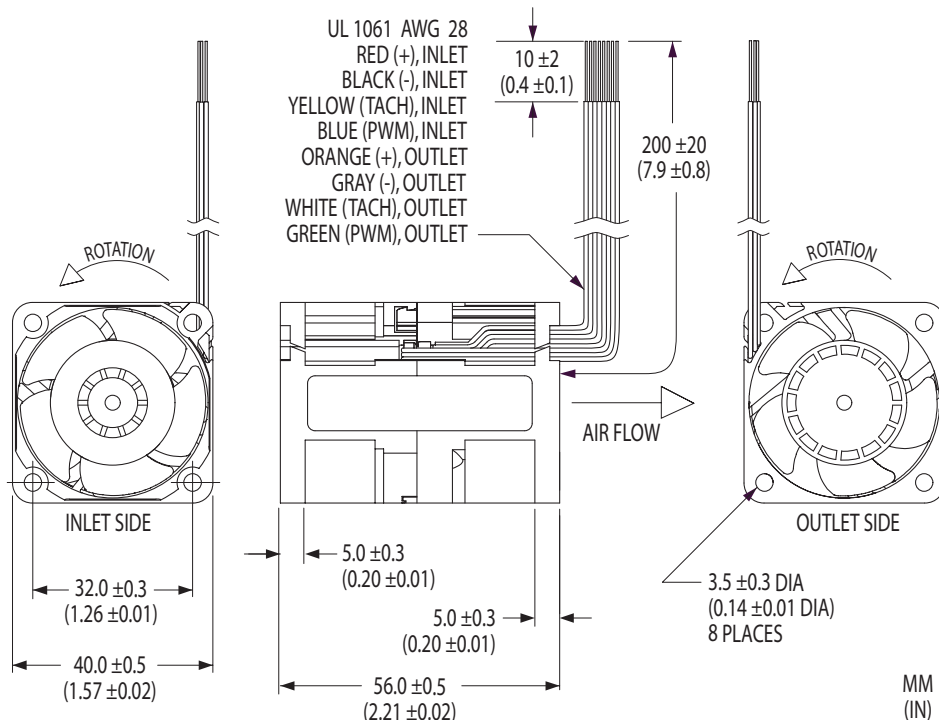

Efficiency Optimized Dual In-Line Counter-Rotating Fans

Model	Air Flow (CFM)	Max. Static Pressure (inwg)	Operating Voltage		Operating Current (A)	Input Power (W)	Fan Speed (rpm)	Sound Pressure (dBA)	Operating Temp.		L10 Life† (hours)
			Nominal (V)	Range (V)					Min. (°C)	Max. (°C)	
Speed-Stable											
R40W12BGCA-07	28	2.5	12	7.0-13.8	1.32	15.8	19200/17200	64.0	-10	+70	50,000
R40W12BHCA-07	25	2.2	12	7.0-13.8	0.95	11.4	18000/13450	60.0	-10	+70	—
Free-Running											
R40W12BGCA-57	28	2.5	12	7.0-13.8	1.32	15.8	19200/17200	64.0	-10	+70	50,000
R40W12BHCA-57	25	2.2	12	7.0-13.8	0.95	11.4	18000/13450	60.0	-10	+70	—

Air flow, current, speed and sound pressure ratings are at nominal operating voltage and zero static pressure. Current and power ratings are average expected values under those conditions. † L10 bearing life expectancy at $T_A = +40^{\circ}\text{C}$. ™ UltraFlo is a brand trademark of Nidec Corporation. N/AJAH

EFFICIENCY GAIN
— Where Needed Most —

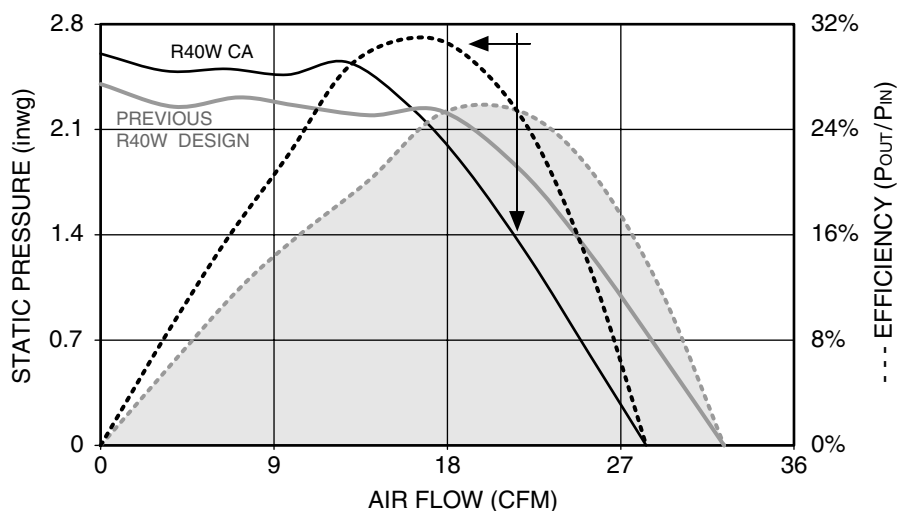

UltraFlo

40x56mm



R40W CA Series

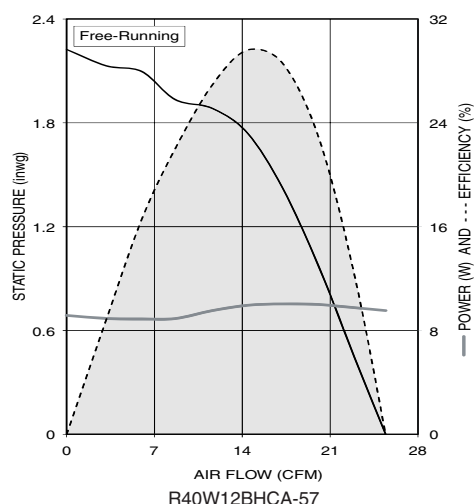
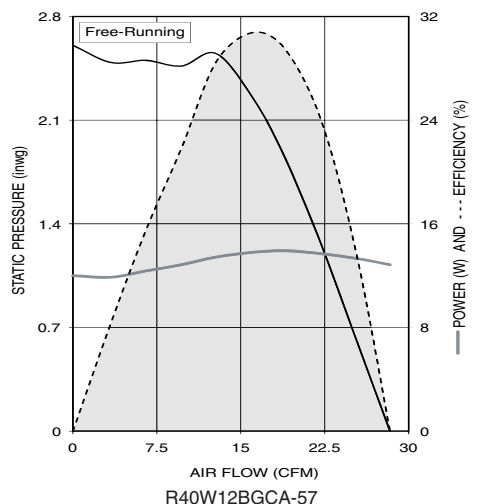
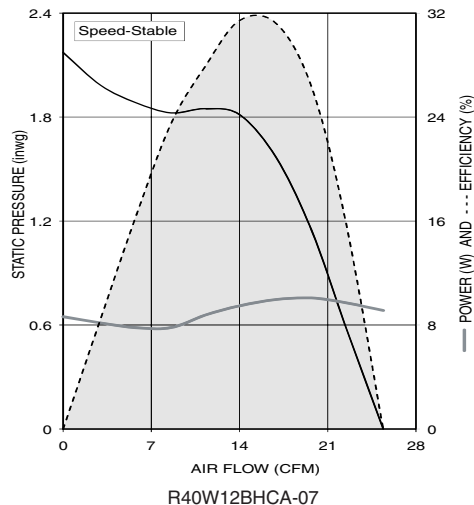
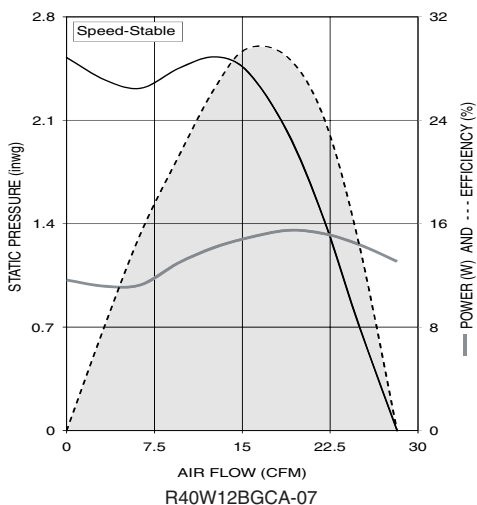

OPEN-COLLECTOR TACHOMETER

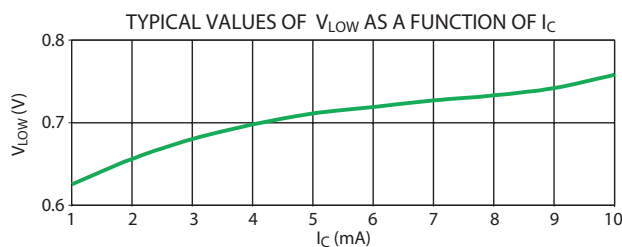
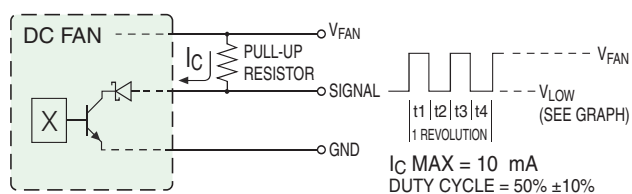

PULSE-WIDTH MODULATED SPEED CONTROL

