

**92x32mm**

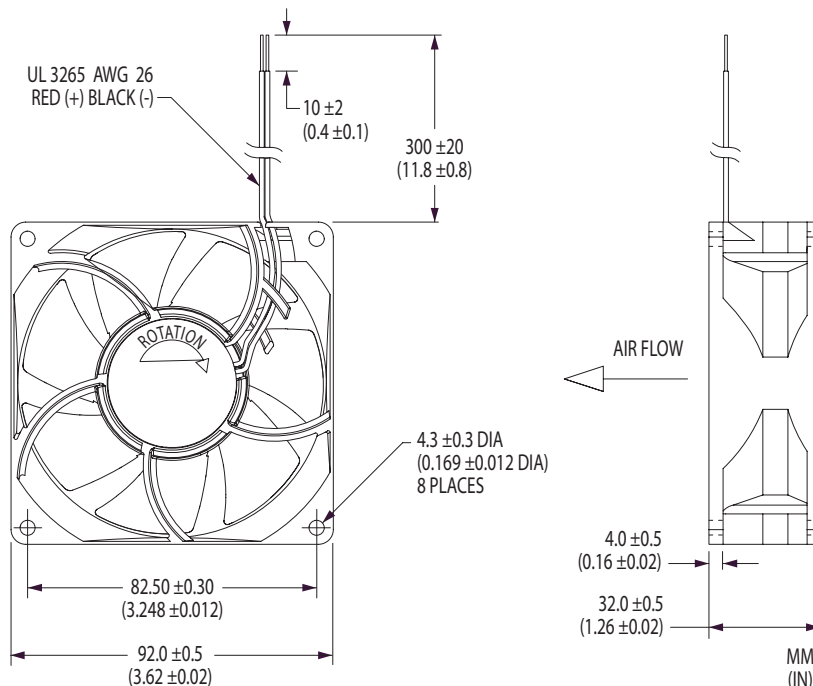

**H92C Series**

- ✓ Free-Running and Feedback-Governed, Speed-Stable Models
- ✓ Wide Variety of Monitor and Control Options and Signal Combinations
- ✓ Permanently Lubricated Dual Ball Bearings



**Hybrid Axial Cooling Fans**

Model	Max. Static		Operating Voltage		Operating Current (A)	Input Power (W)	Fan Speed (rpm)	Sound Pressure (dBA)	Operating Temp.		L10 Life† (hours)
	Air Flow (CFM)	Pressure (inwg)	Nominal (V)	Range (V)					Min. (°C)	Max. (°C)	
<b>Speed-Stable</b>											
H92C12BUA7-01	120	0.90	12	7.0-13.8	1.41	16.9	6000	56.6	-10	+70	70,000
H92C12BGA7-01	97	0.60	12	7.0-13.8	0.78	9.4	5000	52.0	-10	+70	—
H92C12BHA7-01	85	0.50	12	7.0-13.8	0.48	5.8	4300	48.0	-10	+70	—
H92C12BMA7-01	68	0.34	12	7.0-13.8	0.31	3.7	3500	42.5	-10	+70	—
H92C12BLA7-01	56	0.22	12	7.0-13.8	0.19	2.3	2850	36.0	-10	+70	—
<b>Free-Running</b>											
H92C12BUA7-51	120	0.78	12	7.0-13.8	1.41	16.9	6000	56.6	-10	+70	70,000
H92C12BGA7-51	97	0.56	12	7.0-13.8	0.78	9.4	5000	52.0	-10	+70	—
H92C12BHA7-51	85	0.42	12	7.0-13.8	0.48	5.8	4300	48.0	-10	+70	—
H92C12BMA7-51	68	0.30	12	7.0-13.8	0.31	3.7	3500	42.5	-10	+70	—
H92C12BLA7-51	56	0.20	12	7.0-13.8	0.19	2.3	2850	36.0	-10	+70	—

Air flow, current, speed and sound pressure ratings are at nominal operating voltage and zero static pressure. Current and power ratings are average expected values under those conditions. † L10 bearing life expectancy at T<sub>A</sub> = +40°C.™ UltraFlo is a brand trademark of Nidec Corporation.

**Noise Power Emission Levels\***

Operating Voltage (V)	Fraction of Max. Air Flow	Fan Speed (rpm)	Static Pressure (inwg)	NPEL (Bels)
<b>Speed-Stable H92C12BUA7</b>				
13.8	100%	6000	0	6.9
	80%	5990	0.25	6.9
	20%	5990	0.70	7.4
12.0	100%	6000	0	6.9
	80%	5990	0.25	6.9
	20%	5990	0.70	7.4
7.0	100%	4450	0	6.1
	80%	4450	0.14	6.0
	20%	4200	0.38	6.6
<b>Free-Running H92C12BUA7</b>				
13.8	100%	6800	0	7.1
	80%	6460	0.29	7.0
	20%	6020	0.77	7.5
12.0	100%	6000	0	6.9
	80%	5950	0.27	6.9
	20%	5480	0.67	7.3
7.0	100%	3910	0	5.7
	80%	3850	0.12	5.8
	20%	3630	0.32	6.3

UltraFlo

92x32mm

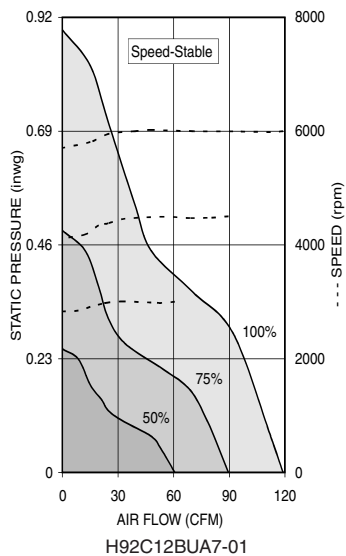

H92C12BUA7-01

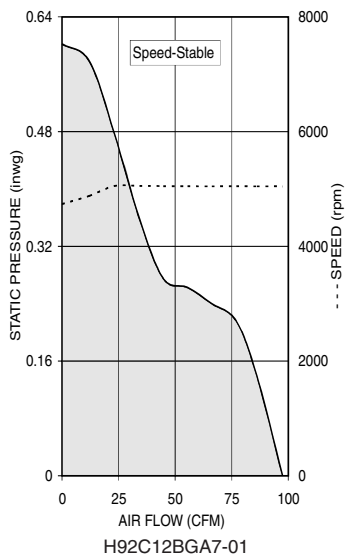

H92C12BGA7-01

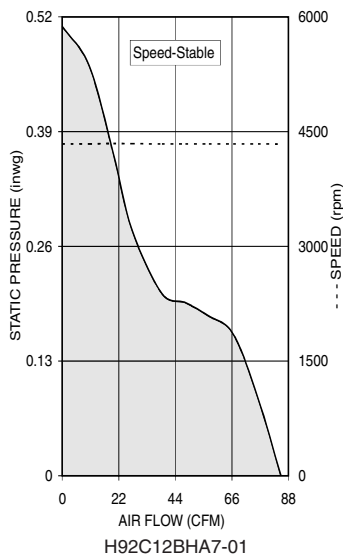

H92C12BHA7-01



H92C Series

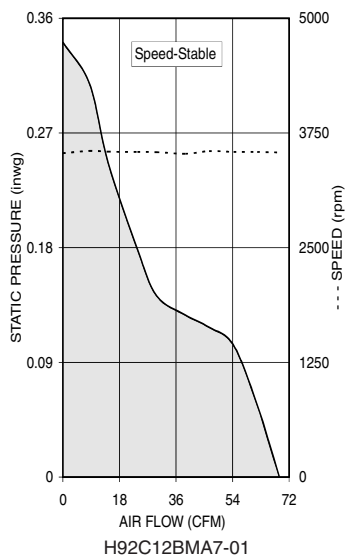

H92C12BMA7-01

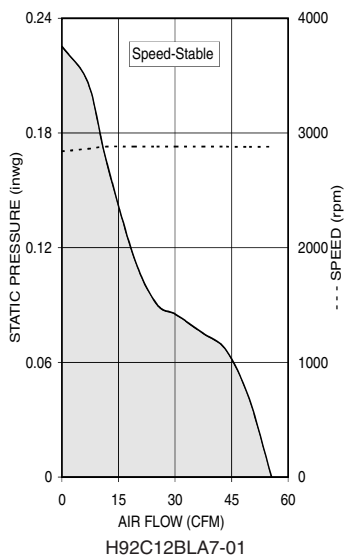

H92C12BLA7-01

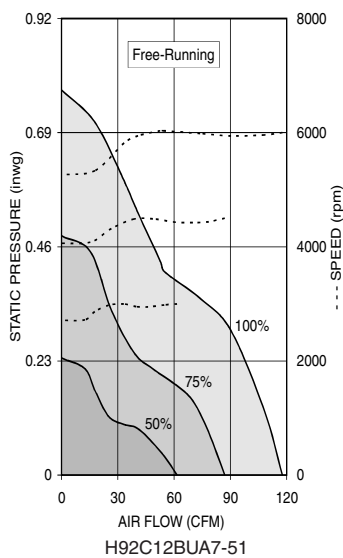

H92C12BUA7-51

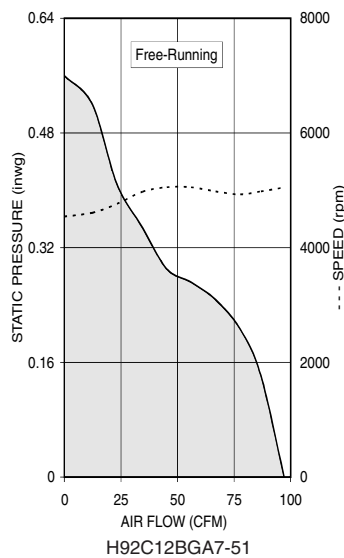

H92C12BGA7-51

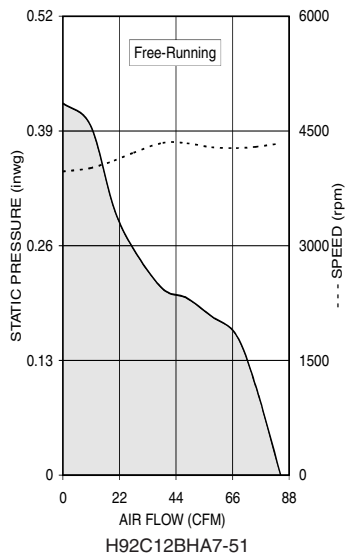

H92C12BHA7-51

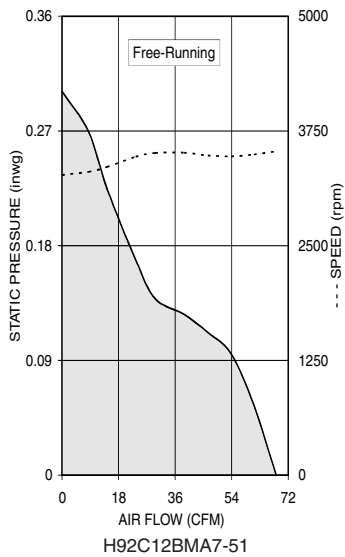

H92C12BMA7-51

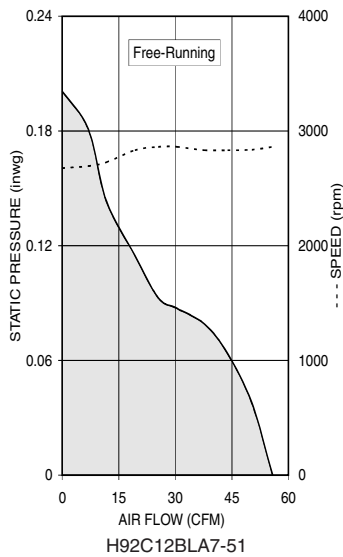

H92C12BLA7-51